

ETH-POE

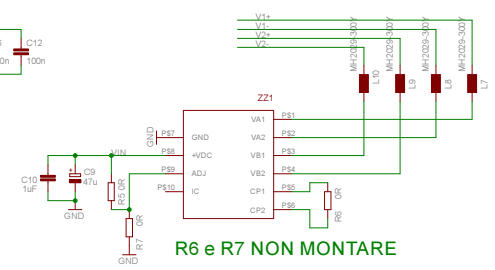
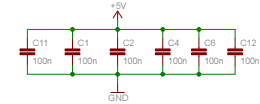
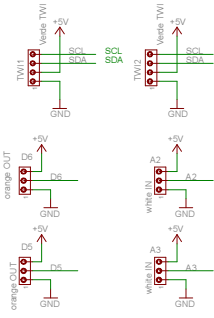
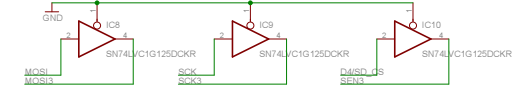
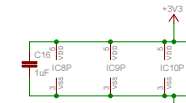
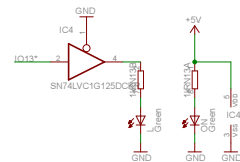
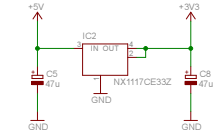
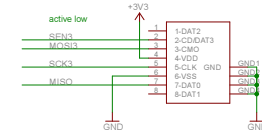
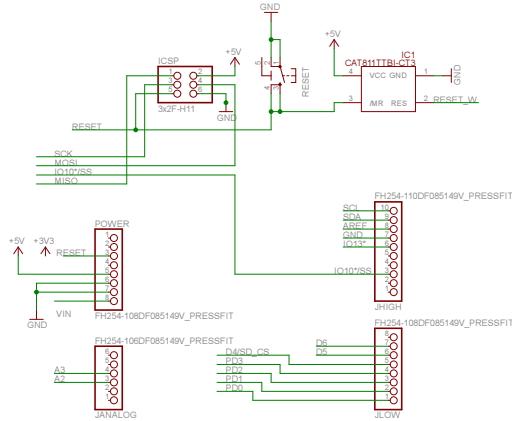
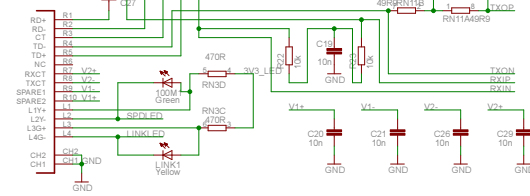

R6 e R7 NON MONTARE

ARDUINO® ETHERNET SHIELD 2

Reference Designs ARE PROVIDED "AS IS" AND "WITH ALL FAULTS". Arduino DISCLAIMS ALL OTHER WARRANTIES, EXPRESS OR IMPLIED, REGARDING PRODUCTS, INCLUDING BUT NOT LIMITED TO, ANY IMPLIED WARRANTIES OF MERCHANTABILITY OR FITNESS FOR A PARTICULAR PURPOSE. Arduino may make changes to specifications and product descriptions at any time, without notice. The Customer must not rely on the absence or characteristics of any features or instructions marked "reserved" or "undefined." Arduino reserves these for future definition and shall have no responsibility whatsoever for conflicts or incompatibilities arising from future changes to them. The product information on the Web Site or Materials is subject to change without notice. Do not finalize a design with this information.

"Arduino" name and logo are trademarks registered by Arduino S.r.l. in Italy, in the European Union and in other countries of the world.

Author: E.Uita	
TITLE: Arduino-Ethernet-Shield2-U2	
Document Number:	REV: U2
Date: 08.04.2015 15:08:25	Sheet: 1/1